



GENUINE ACCESSORIES  
INSTALLATION INSTRUCTIONS

PART NUMBER

0000-8P-L03 Mazda5  
0000-8P-M03 CX-7  
0000-8P-N03 CX-9  
0000-8P-Z03 Mazda3, Mazda6

# MOONROOF WIND DEFLECTOR

KIT CONTENTS

End Brackets	Center Bracket	Screws	Protective Film
0000-8P-L04 Mazda5			
0000-8P-M04 CX-7			
0000-8P-N04 CX-9			
0000-8P-Z04 Mazda3, Mazda6			

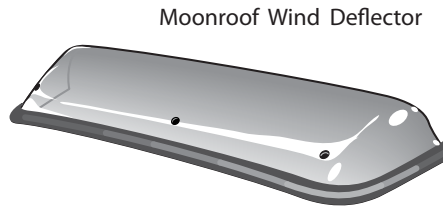

TOOLS REQUIRED

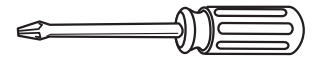

No. 2 Phillips Screw Driver

## 0 Before Installation

**CAUTION:** Beware of any sharp edges on vehicle, or potential interferences with any roof rack attachments such as skis, canoes, etc.

1. Clean and wax the area around vehicle moonroof opening prior to installation of the deflector

## 1 Installation

1. Open moonroof and turn off the ignition.
2. Loosely assemble brackets to wind deflector using supplied screws and brackets. Place the center bracket in the center hole location. Leave screws as loose as possible, engaging only two to three threads. (Fig. 1 & 2)
3. Be sure black rubber gasket is seated properly in its groove along the entire front edge of deflector.
4. Position the deflector along the front of the moonroof opening. (Fig. 3).

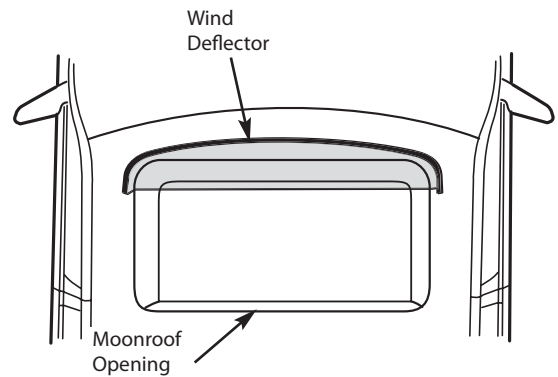
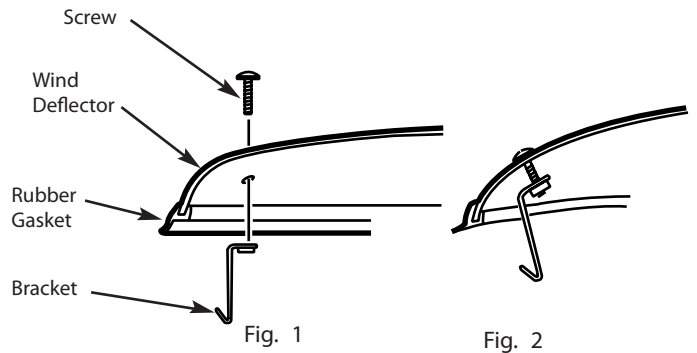

## Installation Continued

5. Properly locate the deflector and assure:
  - a. The black rubber gasket is positioned forward to the front edge of the moonroof opening.
  - b. The deflector is centered side to side.
  - c. The mounting brackets are centered under the mounting holes in the deflector. (Fig. 5)
  - d. Mark the bracket locations with a pen.
  - e. Remove the deflector and carefully set aside

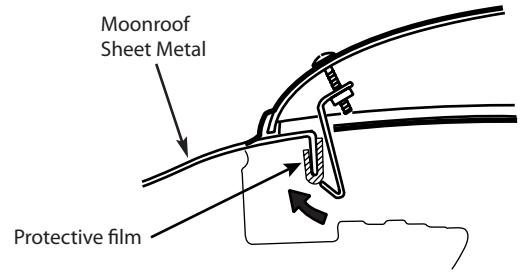

Fig. 4

6. a. Thoroughly clean the locations where the brackets will mount. (Fig. 5)  
b. Apply protective film to the sheetmetal locations marked in step (d) above.

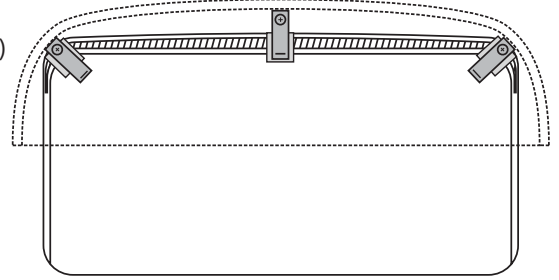

Fig. 5

7. Hook a bracket under the edge of the sheet metal in the front corner of the moonroof opening on each side of the vehicle. Do not tighten down screws at this point. (Fig 4 & 5) Make sure bracket is hooked to the lowest part of the sheet metal.
8. Carefully tighten down screws making sure that the deflector does not shift position. Tighten screw on bracket until gasket is fully seated to roof sheet metal.
9. Check to make sure the black rubber gasket is seated to the roof of the vehicle all the way around the deflector. Additionally, check to make sure gaskets is not folded over at any point along its edge.
9. Tighten screws if necessary to achieve a good seal.
10. Turn on ignition and close moonroof.

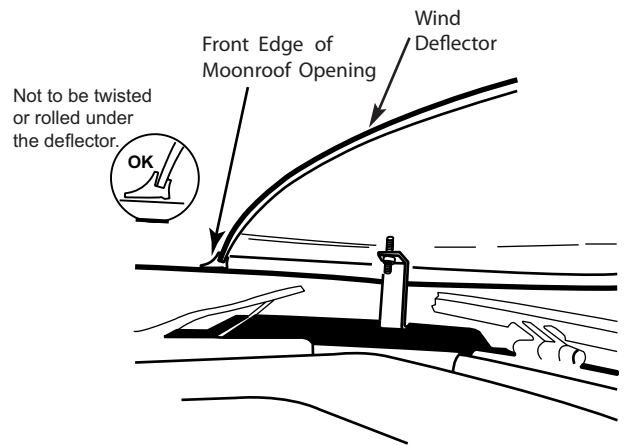

Fig. 6

**CAUTION:** Make sure there is no interference with the deflector.

## 2 Cleaning Instructions

1. Use mild soap to clean the deflector. Do not use ammonia or glass cleaners containing ammonia. This will damage the surface finish of the deflector.